



EG1000 OWNER'S MANUAL

**1000W MAX POWER
ELECTRIC GO-KART**



Read and understand this manual before riding!

Always wear a helmet it could save your life! This Go-kart is designed for operators age 13 and over. Adult supervision is required for riders age 16 and under!

Provincial/Municipal governments have different regulations pertaining to owning and operating an off-road vehicle, learn the regulations in your area.

www.evoltadventure.com

To the Owner

Congratulations on your purchase of a EG100 Go Kart. This Owner's/Operator's manual will provide you information regarding safe operation, operational instructions, maintenance and care. Fully understanding this manual and following all of the instructions herein will provide the knowledge needed to have safe and enjoyable Go Kart operation.

Safety - Notice to parents

The recommended age for operating this Go Kart is 13 and over. Even though a child may meet the minimum recommended age, children differ in skills, physical abilities, and judgement. Some children may not be able to operate the Go Kart safely. Parents should permit continued use only if they determine that the child has the ability to operate the Go Kart in a safe manner.

THIS Go Kart IS NOT A TOY AND COULD BE HAZARDOUS TO OPERATE. A Go Kart handles differently from other vehicles including motorcycles and cars. A collision or rollover can occur quickly, even during routine maneuvers such as turning, driving on hills and over obstacles.

Reading the Owner's/ Operator's Manual

It is important this manual is read from cover to cover carefully by the Go Kart owner and all operators. Parents should review the manual carefully with their children. Never allow anyone to operate the Go Kart without first reading and understanding the Owner's/Operator's manual.

This Owner's/ Operator's manual should be a permanent part of the Go Kart and should remain with the vehicle at all times. The manual should also remain with the vehicle if sold.

To emphasize special important information in the manual, please note the following :



This is the alert symbol. The symbol means **ATTENTION!, BECOME ALERT!**

To emphasize important safety information, the word **WARNING**, with the alert symbol, has special meaning:



WARNING

Indicates a potential hazard that could result in **SEVERE INJURY** or **DEATH** to the operator, bystander or person repairing the go-kart.

To emphasize important information, the word **CAUTION** has special meaning:

CAUTION:

Indicates special precautions that must be taken to avoid damage to the Go Kart.

To emphasize important information, the word **NOTE** has special meaning:

NOTE:

Indicates key information to make procedures easier or clearer to understand.



WARNING or **CAUTION**

The first part will identify a **POTENTIAL HAZARD**.

The second part will describe **WHAT COULD HAPPEN** if the warning or caution is ignored.

The third part will describe **HOW TO AVOID THE HAZARD**.

We are concerned about the environment and believe in conserving and protecting all natural resources. For this reason, owners should recycle, trade in, or dispose as appropriate batteries and other parts.

This manual is based on the latest product information available at the time of publication. We have a policy of continually improving its products. Due to improvements, or other changes, there may be some discrepancies. We reserve the right to make product changes at any time, without notice and without incurring any obligation to make the same or similar changes to vehicles previously built or sold.

IMPORTANT LABELS

LOCATION

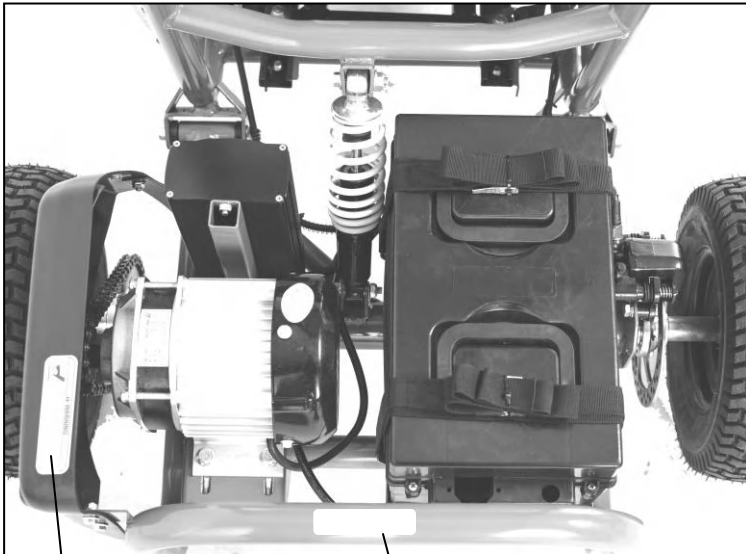
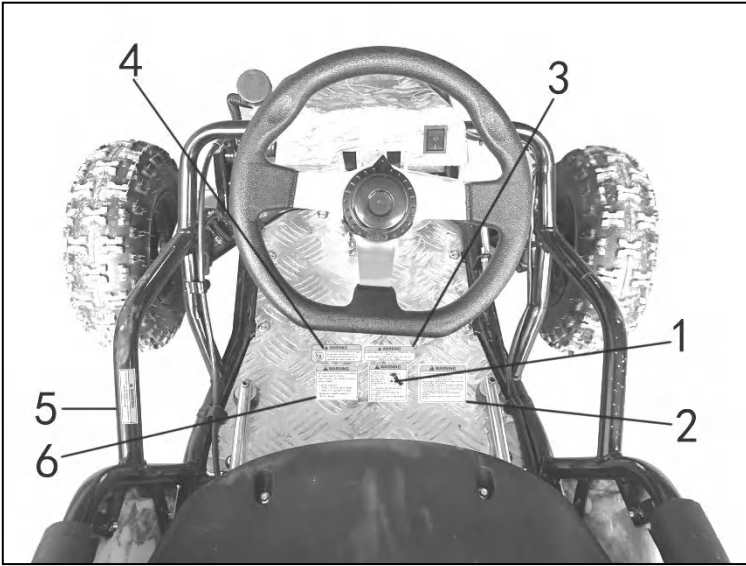

7

8

IMPORTANT LABELS

WARNING LABELS

1

WARNING

THIS GO-KART CAN BE HAZARDOUS TO OPERATE IF DRIVEN CARELESSLY. INJURIES CAN RESULT IF YOU DO NOT FOLLOW THESE INSTRUCTIONS:

- READ OWNER'S MANUAL AND ALL LABELS BEFORE YOU OPERATE THIS GO-KART.
- NEVER OPERATE THIS GO-KART WITHOUT PROPER INSTRUCTIONS. Beginners require mature supervision.
- NEVER OPERATE THIS GO-KART ON PUBLIC ROADS. It is intended for off-road use only.
- NEVER OPERATE THIS GO-KART AT EXCESSIVE SPEEDS.
- NEVER ATTEMPT WHEELIES, JUMPS, OR OTHER STUNTS.

6

WARNING

Improper tire pressure or overloading can cause loss of control. Loss of control can result in severe injury or death.

- Cold tire pressure:
Front: 14 ± 1psi (96.5 ± 7kpa)
Rear: 14 ± 1psi (96.5 ± 7kpa)
- Maximum weight capacity is 150 lbs. (68 kg)

2

WARNING

FAILING TO TIE UP LONG HAIR COULD RESULT IN HAIR GETTING CAUGHT IN MOVING PARTS RESULTING IN SEVERE INJURY OR DEATH



ALL HAIR MUST BE TIED UP ABOVE SHOULDER LENGTH.
ALL LOOSE CLOTHING MUST BE SECURED.
ALL NECKLACES AND SCARVES MUST BE SECURED

7

WARNING



Keep hands and fingers away from chains and sprockets. Make sure guards are securely in place before operation.

3

WARNING

ALWAYS WEAR SEAT BELT WHILE OPERATING THIS VEHICLE.
KEEP HANDS, ARMS, FEET AND LEGS IN THE VEHICLE AT ALL TIMES.

8

WARNING



DO NOT RIDE ON BACK OF VEHICLE

4

WARNING



The recommended minimum age to operate this vehicle is 13. Continual adult supervision is required for riders under 16.

5

WARNING

THIS GO-KART IS DESIGNED FOR ONE OPERATOR AND NO PASSENGERS.

SAFETY

1. Always read and understand the Owner's/Operator's manual and warnings before starting the Go Kart for the first time
2. This Go Kart should only be assembled by someone who has the knowledge, ability and skills to read and understand mechanical instructions.
3. Use caution when providing maintenance on this Go Kart. Make sure engine is turned off and all components are cool. Never attempt to make any adjustments while engine is running.
4. Do not modify this Go Kart in any way, modifications could make the Go-Kart unsafe and/or in violation of Federal and State laws.
5. This Go Kart is recommended for riders 13 and older.
6. Always wear a certified DOT motorcycle or ATV helmet that fits properly.
7. This Go Kart is designed for one operator and no passengers.
8. Always wear seat belt provided. Make sure seat belts fit properly before starting the Go Kart.
9. Never operate this Go Kart on paved surfaces and/or public roads. Pavement may cause the Go Kart to become unstable.
10. The head bar in back of the operator is not intended to provide rollover protection. Before each use, make sure all tubes are securely in place and bolts are tight.
11. Never operate Go Kart with long hair, loose jewelry or loose clothing that could get caught in moving parts.
12. Always go slow on unfamiliar terrain. Be alert to changing terrain conditions when operating the Go Kart.
13. Never take drugs or alcohol before or during operation of this Go Kart.
14. Never attempt jumps or any other type of stunts while operating this Go Kart.
15. Always follow the pre-ride inspection procedures and maintenance procedures located in this manual before use.
16. Always go slow on terrain that is not familiar, be alert, an obstacle could come up unexpectedly.
17. Always keep hands, arms, legs and feet inside the Go Kart at all times.
18. Never operate Go Kart in water that is deeper than 2 inches. Do not operate in fast flowing water. Water can affect braking performance of the Go Kart. Check braking performance after exposure to water, it may be necessary to apply the brakes allowing friction to dry out the pads.

DESCRIPTIONS AND PART LOCATIONS

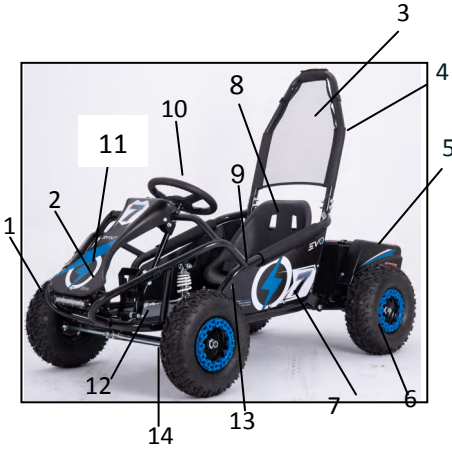

1. Front tires
2. Plastic nose piece
3. Net
4. Head bracket assembly
5. Chain cover
6. Rear tires
7. Side panel
8. Seat
9. Seat belt
10. Steering wheel
11. Accelerator pedal
12. Brake pedal
13. Brake fluid reservoir
14. Tie rods
15. Rear brake caliper
16. Rear axle
17. Drive chain
18. Motor
19. Motor controller
20. Battery

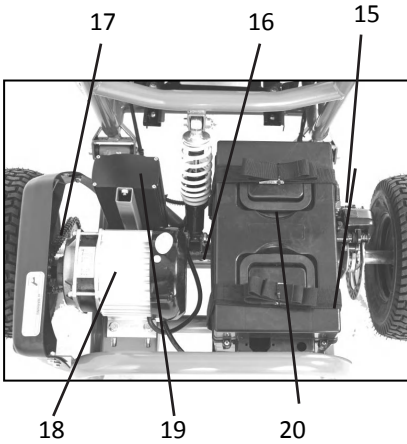

DESCRIPTION AND PART FUNCTIONS



4 3 2 1

Power Switch (1): When the power switch is placed in the (ON) position the motor can run. Please keep the power switch in the (OFF) position when you leave the vehicle, park or stop.

Meter (2): Shows battery level.

Gear Switch (3): when the Gear switch is place in the (High) position the vehicle can reach the top speed. When the Gear switch is place in the (Low) position the vehicle will go half speed.

Forward or Reverse Switch (3): when the Forward or Reverse Switch is place in the (Forward) position the vehicle will go Forward. When the Gear switch is place in the (Reverse) position the vehicle will go Reverse.

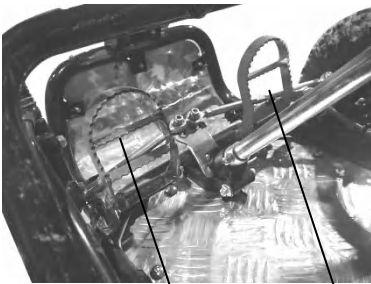

5 6

Brake Pedal (5): Depressing the brake pedal will stop the Go Kart. Note: Always check brakes before operation

Accelerator Pedal (6): Depressing accelerator pedal will increase motor power causing Go Kart to move forward or reverse.

DESCRIPTION AND PART FUNCTIONS

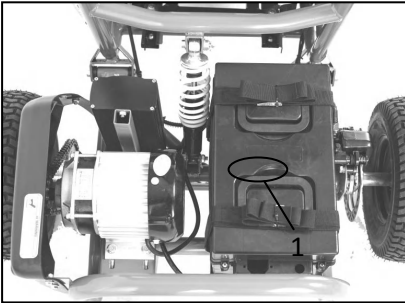

Battery and Charging port (1):
To connect the power plug from the controller or charge plug.

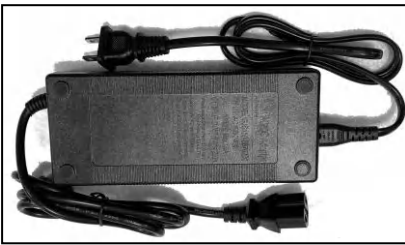

Battery Charger (2)
Input: AC100-240AC~50/60Hz
Max 1.6A
Output: DC57.6V-2.0A

Warning: the Charger is for indoor use only. Risk electric shock please do not open the charger.

2

DESCRIPTION AND PART FUNCTIONS

SEAT ADJUSTMENT

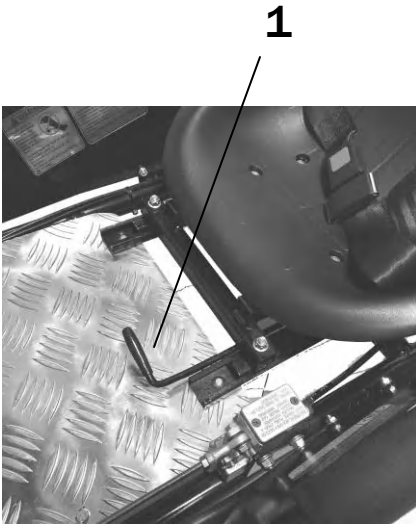

⚠ WARNING

Failure to have the seat locked in position could be hazardous.

The seat coming loose could cause the operator to lose control.

Never operate the Go Kart without the seat locked in place.

Seat adjustment (1)

The seat Lever is located on the left side of the go-kart. Pull up seat lever to move the seat forward or backward. Set seat location according to the size of the operator. Before operating the Go-Kart after seat adjustment, make sure the seat is locked in place and secure.

PRE-RIDE INSPECTION

Inspecting and checking the condition of the Go Kart before each ride is important. Following the pre-ride check list will help insure the you do not have mechanical problems which could result in injury or becoming stranded. Make sure the Go Kart is in good operating condition before each ride.

WARNING

Failing to inspect and maintain your Go Kart could be hazardous.

Not following the pre-ride inspection procedures could result in loosing control of the Go Kart resulting in an accident or damage to the Go Kart.

Always perform a Pre-ride inspection before operating.

WARNING

Performing maintenance and checks while the engine is running could be hazardous.

You could be severely injured by moving parts or hot surfaces.

Never perform maintenance or check procedures while the engine is running with the exception of checking the ignition switch or throttle.

WHAT TO CHECK	CHECK FOR
Steering	<ul style="list-style-type: none"> • Smoothness • No restriction of movement
Brakes	<ul style="list-style-type: none"> • Correct fluid level • Inspect hoses for leaks • Inspect brake pads for wear.
Tires	<ul style="list-style-type: none"> • Proper tire pressure • Proper tread depth • Rubber has
Battery	<ul style="list-style-type: none"> • Enough power the ride • wires secure
Accelerator Pedal	<ul style="list-style-type: none"> • Operates freely
Power switch	<ul style="list-style-type: none"> • Switch can power –on and power-off the
Drive Chain	<ul style="list-style-type: none"> • Proper tension • Lubricated
General Condition	<ul style="list-style-type: none"> • All nuts and bolts tight • No rattles from motor or frame

OPERATING THE GO KART

WARNING

Carrying a passenger on this Go Kart could be hazardous

Carrying a passenger could cause loss of control resulting in severe injury or death to the operator and/or passengers.

This Go Kart is designed for one operator and no passengers. Never allow a passenger on this Go Kart.

WARNING

Operating this Go Kart in a irresponsible manner which includes jumping or other stunts could be hazardous.

Jumping or other stunts could result in loss of control of the Go Kart resulting in severe injury or death.

Never attempt stunts, such as jumping.

WARNING

Operating this Go Kart on paved surfaces could be hazardous.

Operating on paved surfaces , including parking lots, sidewalks, driveways and streets can cause loss of control resulting in severe injury or death. Go Kart tires are designed for off-road use only, paved surfaces adversely affect handling and control.

Avoid operating Go Kart on paved surfaces. If you must cross a paved surface, go slow and do not make sudden turns or stops.

WARNING

Operating a Go Kart on hills could be hazardous.

Operating a Go Kart on a hill could result in rolling over while traversing, flipping over backwards while climbing, flipping over while descending, general loss of control of the Go Kart. Any of these accidents on a hill could result in severe injury or death.

Never operate a Go Kart on steep hills.

WARNING

Operating this Go Kart on any public road or highway could be hazardous.

You could collide with another vehicle if you operate on public roads or highways resulting in severe injury or death.

Never operate on public roads or highways.

OPERATING THE GO KART

HELMET, EYE PROTECTION, PROTECTIVE CLOTHING

Always wear a DOT certified helmet (1). A helmet helps protect against serious head injuries in the event of an accident. A helmet is the most important safety gear item you can wear. Consult with a motorcycle dealer for the correct size and type of helmet that is right for you.

Always wear eye protection when operating a Go Kart such as a face shield or goggles (2). While operating a Go Kart you can be hit in the eyes by any of the following: dust, branches, rocks, debris from other operators, bugs, etc. Good eye protection as well as a helmet and protective operating gear should be mandatory when operating a Go Kart.

Wear protective clothing: Long sleeve shirt (3), Gloves (4), Long pants (5), over the ankle boots (6). Operating a Go Kart exposes the operator to many hazards, wearing protective clothing can help protect the operator from injury.

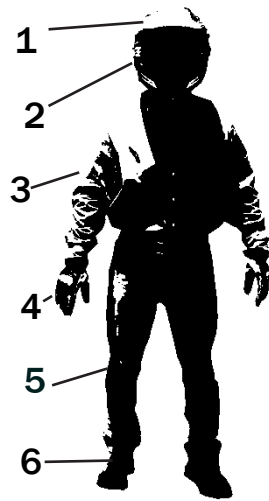

⚠ WARNING

Operating a Go Kart without a helmet, eye protection, and protective clothing can be hazardous

Operating a Go Kart without a helmet increases the chance of severe head injury or death in the event of an accident.

Operating a Go Kart without eye protection such as a face shield or goggles could result in severe injury in the event of an accident.

Operating a Go Kart without protective clothing; closed toe shoes, long pants, gloves, long sleeve shirt could result in severe injury in the event of an accident.

Always wear a Helmet, eye protection, long pants, long sleeve shirt, over the ankle boots and gloves while operating a Go Kart.

OPERATING THE GO KART

SEAT BELTS

WARNING

Riding in this go kart without the seat belt attached properly could be hazardous

Riding the go kart without the seat belt worn increases the chance of injury or death in the event of an accident

Never operate the go kart without the seat belt worn and attached properly.

To connect the seat belt sit in the seat and buckle the lap belt. Make sure the buckle is latched properly.



OPERATING THE GO KART

STARTING

1. Connect the battery wires.
2. Place the Power switch , located on the Steering column, in the “ON” position
3. Place the Forward or Reverse Switch in the “Forward” position.

WARNING

Removing hands from the Steering wheel and/or feet from the floorboard while operating the Go-Kart could be hazardous.

Removing both or one hand from the Steering wheel and/or feet from the floorboard could result in loss of control of the Go-Kart resulting in severe injury or death.

Always Operate with both hands on the steering wheel and both feet on the floorboard while operating the Go-Kart.

WARNING

Operating this Go-Kart at excessive speeds could be hazardous.

Driving at excessive speeds increases your chances of losing control of the Go-Kart, which could result in severe injury or death.

Always go at a speed that is proper for the terrain, visibility, operating conditions, operator skill, and operator experience. Always know the terrain before operating.

WARNING

Applying the Accelerator Pedal to full throttle when starting off could be hazardous.

The Go-Kart could lurch forward causing the front wheels to leave the ground causing loss of control.

Always open the throttle gradually when starting off from a stopped position.

WARNING

Braking while turning could be hazardous.

Braking while turning could cause the Go-Kart to slide out of control or flip over which could result in severe injury or death.

Before making a turn, slow down and release the brake.

OPERATING THE GO KART

CLIMBING A HILL

1. Stop and evaluate the hill before attempting to climb. Make sure the hill is not too steep, the terrain is not loose or slippery and that there are no obstacles.
2. Approach the hill at a steady speed and maintain speed throughout the climb.
3. When approaching the top of the hill, slow down.

If it is determined that the Go Kart will not make it to the top of the hill:

1. Do not try to turn the Go Kart around while operating and come back down, this could cause the Go Kart to roll over.
2. Slowly back the Go Kart down the hill while applying the brakes.

DESCENDING A HILL

To operate the Go Kart going down a hill, follow the instructions below.

1. Stop and evaluate the hill before attempting to descend. Make sure the hill is not too steep, the terrain is not loose or slippery and that there are no obstacles.
2. Do not go down the hill on a sharp angle, this could cause the Go Kart to flip over. Instead, go straight down the hill. Apply the brakes on the way down.

TRAVERSING A HILL

WARNING

Traversing a hill could be hazardous.

Traversing a hill could result in losing control and flipping the Go Kart over.

This could result in severe injury or death.

Never attempt to traverse a hill that is too steep or has loose or slippery terrain.

OPERATING THE GO KART

SKIDDING OR SLIDING

In certain situations you may experience skidding or sliding even though the brakes are not applied. Follow the operating techniques listed below to regain control.

Front wheel begins to slide or skid:
To regain traction, let off the throttle, do not apply the brakes.

Rear wheels begin to slide or skid:
To regain traction, let off the throttle and brakes until control of the Go Kart is achieved, steer in the direction of the skid.

WARNING

Skidding or sliding of the Go Kart could be hazardous.

Skidding or sliding could result in the Go Kart sliding into an object or overturning suddenly by regaining traction resulting in severe injury or death.

Avoid skidding or sliding. Drive to stay in control.

WARNING

Applying the parking brake while operating the Go Kart could be hazardous.

Applying the parking brake while operating can cause the wheels to lock up and the Go Kart to slide out of control. The Go Kart could turn over or slide into an object. This could result in severe injury or death.

Apply the parking brake only after the Go Kart has come to a complete stop.

WARNING

Applying the brakes hard on slippery surfaces could be hazardous.

Applying the brakes too hard on a slippery surface can cause the wheels to lock up and the Go Kart to slide out of control. The Go Kart could turn over or slide into an object. This could result in severe injury or death. Gently apply the brakes when on a slippery surface.

OPERATING THE GO KART

OPERATING THROUGH WATER

Operating through water can be hazardous, especially if it is fast moving. Make sure the water you are operating through is shallow and is not more than 5cm (2in) deep. Before crossing any water look at the terrain entering and exiting the water, the terrain should have a gradual slope with no obstacles. The bottom of the river or pool of shallow water should be hard. If you do not know the terrain or are not sure about the bottom of the pool or river, do attempt to enter. Remember to protect the environment, do not enter a river or pool of water if doing so could damage the river bank or shore line.

Brakes need to be inspected, cleaned and replaced more often if Go Kart is used in muddy, wet or sandy conditions. Inspect the Go Kart brakes regularly, have a service center clean or replace as needed.

WARNING

Operating this Go Kart through fast or deep water could be hazardous;

Deep or fast moving water could cause the Go Kart to loose traction resulting in loss of control which could lead to severe injury or death.

Never operate this Go Kart in water that is more than 2in (5cm) deep. Never operate this Go Kart in fast moving water. Always check brakes after operating through water, wet brakes can reduce stopping ability. Make sure brakes are dried out. The brakes can be dried out from friction by applying the brakes multiple times.

OPERATING THE GO KART

OPERATING IN COLD WEATHER - PRE RIDE INSPECTION

Brake and throttle linkages:

Cold weather requires additional pre-ride inspection of the Go Kart before operating. Inspect brake and throttle linkages making sure they operate freely and correctly. Ice and snow can cause these items to freeze. If the linkages are frozen, move the Go Kart to a warm area until these items thaw and work properly.

Frozen tires:

Check to make sure the Go Kart tires are not frozen to the ground, if they are, pour warm water around the tires to release. Do not attempt to break the Go Kart loose using engine power, this could damage the engine and drive train.

Brake inspection:

Start engine and allow to warm up. Check the braking ability of the Go Kart by applying the brakes on level ground while traveling at a slow (walking rate) of speed. Make sure both front and rear brakes work properly. If the front, rear, or both sets of brakes do not work, take the Go Kart to a warm area to thaw out. Once brakes are thawed, check again for proper operation, if they still do not work, take the Go Kart to a authorized service center. Do not attempt to operate the Go Kart with brakes that do not work correctly.

Preventive maintenance in cold weather operating is important. After operating in cold weather with snow, slush, water or ice, dry off the Go Kart including brake and throttle linkages. Apply the brakes several times making sure that the friction has dried off the brake pads and shoes. Cover the Go Kart with a protective cover so ice and snow cannot accumulate .

CAUTION

Using motor power to release wheels that are frozen to the ground could damage Go Kart.

Damage to engine and drive train may occur if attempting to use motor power to free frozen wheels.

Always make sure wheels move freely before starting the Go Kart in cold weather.

WARNING

Operating the Go Kart with wet or frozen brakes could be hazardous.

Wet or frozen brakes will increase stopping distance which could result in loss of control which could result in severe injury or death.

Always inspect the brakes before each ride by following the procedures in this manual.

OPERATING THE GO KART

LOAD GUIDELINES

Load guidelines including accessories:

Never exceed the maximum load capability of the Go Kart. This includes the weight of the operator and any cargo. This Go Kart is rated at 150 lbs. (68kg)..

Never allow a passenger. This Go Kart is designed for one operator and no passengers.

Do not add any accessory or cargo to the steering wheel that could impede vision or make the Go Kart harder to steer.

Make sure accessories do not get in the way of any controls of the Go Kart.

AFTER MARKET PARTS

After market parts and accessories are available from many manufactures. We cannot confirm the quality, safety or suitability of all the accessories available. When purchasing an accessory, use caution, the handling of the Go Kart could become affected. Some accessories may make the Go Kart unsafe to operate. If you have a question about a modification or accessory, contact your dealer.

WARNING

Modifications or adding accessories could be hazardous.

Modifications to the Go Kart, including adding accessories, could adversely affect the handling of the Go Kart causing an accident which could result in severe injury or death.

Never Modify this Go Kart in anyway, including adding accessories, unless the modification is a genuine certified modification or accessory approved by the manufacture. Never modify the Go Kart with improper installation. Make sure to follow all instructions recommended in the certified modification. Use only genuine parts. For questions, contact your dealer.

MAINTENANCE

For maintenance, your Go Kart may be maintained by an authorized service center or a repair shop of your choosing.

Following the proper maintenance procedures and time table for maintenance listed in this manual is important for the safety of the operator and the life span of the Go Kart. When operating in harsh conditions, such as water, mud and dust, the maintenance procedures should be performed more often.

WARNING

Failing to perform the recommended maintenance on this Go Kart could be hazardous.

Failing to perform proper maintenance on this Go Kart could result in an accident

Always perform the recommended maintenance for the Go Kart as listed in this manual.

WARNING

Performing maintenance and inspection while the motor is running could be hazardous.

Performing maintenance and inspections while the motor is running could result in getting body parts or clothing caught in moving parts, or could result in touching hot items which could result in severe injury.

Shut off motor when performing maintenance and inspection checks, with the exception checking the ignition switch and throttle.

CAUTION

Failing to perform recommended maintenance on this Go Kart could damage the Go Kart engine and components.

Always perform the recommended maintenance on this Go Kart as listed in this manual. Maintenance will need to be performed more often if ridden in wet, muddy or dusty conditions.

CAUTION

Failing to use compatible parts with the original replacement parts could damage Go Kart.

Using parts that are of low quality could result in Go Kart breakdowns and reduce the useful life of the Go Kart.

Never use parts that are not compatible with the original parts.

MAINTENANCE

ITEM	First 5 hours of operation	Before each ride	Every 20 hours of operation or 1 month	Every 50 hours or 3 months	Every 100 hours or 6 months
Condition of throttle and brake cables	I	I			
Drive Chain	Inspect				
Brakes	I		I		
Brake hose	I		I		
Brake fluid	Inspect				
Tires		I			
Steering	I		I		
Front suspension	I				
Rear suspension	I		I		
Chassis nuts and bolts	T	I	T		

**** Recommended to be performed by an authorized service center or service center of the owner's choosing.**

MAINTENANCE

BRAKES

This Go Kart is equipped with rear hydraulic disk brakes

⚠ WARNING

Failing to inspect brakes before each use could be hazardous

Inspect brakes before each use according to the Pre-ride check list, make sure to follow the maintenance schedule and procedures.

BRAKE FLUID INSPECTION

Check the brake fluid level (1) for rear brakes. If fluid level is below the lower mark, inspect the brake hoses (2) for leaks or cracks. If there are no leaks, inspect the brake pads for excessive wear. If brake pads are worn, take to a service center for replacement.

To add brake fluid, remove the lid (3). Use only DOT3 or DOT4 brake fluid

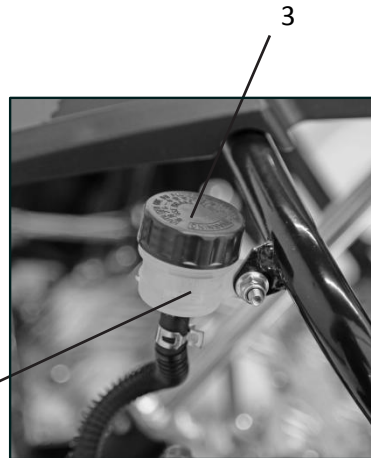

1

2

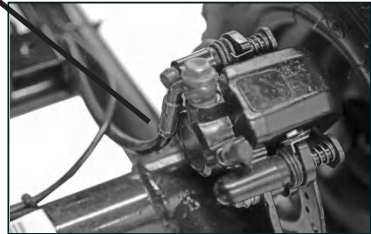

MAINTENANCE

Chain and Sprocket inspection

Inspect drive chain for wear, rust, bound links, proper lubrication and proper tension.

If drive chain has a problem, correct or replace. Contact a service center for chain replacement.

A worn drive chain could also mean the sprockets may be worn. Look for the following on sprockets (1): Worn teeth, broken or damaged teeth, loose sprocket mounting nuts.

If sprockets show signs of wear, contact a service center for replacement.

Chain Lubrication

Lubricating the chain before each ride will help to ensure maximum life of the chain and sprockets.

Instructions for cleaning and chain lubrication:

1. Clean chain with a chain cleaner or a cleaning lubricant such as WD40.
2. Lubricate chain with chain lube.

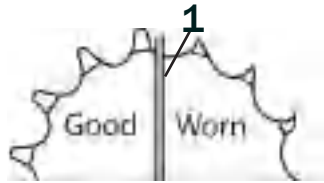

Chain Tension

⚠ WARNING

Checking chain tension while the engine is running can cause serious injury.

Always make sure engine is off before checking drive chain tension.

Check tension of drive chain (2), chain tension slack should be 0.2 - 0.5in (5 - 13mm)

Chain tension (slack) Adjustment

1. Loosen nuts (3) on bottom of engine mounting plate.
2. Adjust chain tension by pulling engine backward (tightening) or forward (loosening) chain tension nuts (4).
3. Once the chain is at the correct tension re-tighten nut (3).
4. Re-check chain tension.

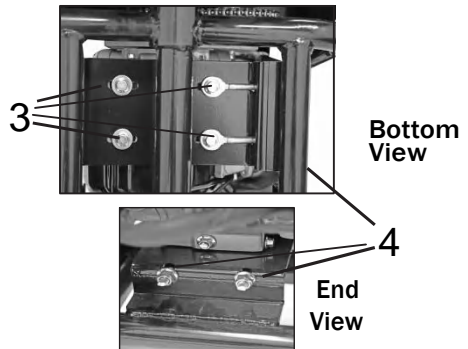
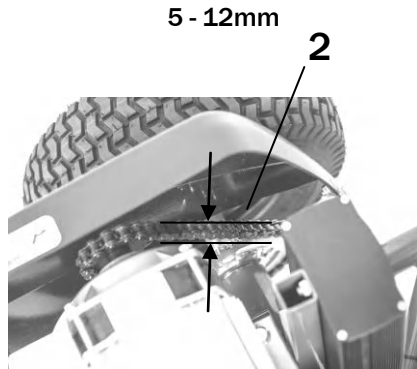

MAINTENANCE

TIRES

Inspect tires before each ride, this should include the following:

1. Inspect for cracks or leaks
2. Inspect tread depth. If tread depth is below 4mm (.16 in.) replace the tire.
3. Check tire pressure. Incorrect tire pressure can affect the handling, operator comfort, steering, tire life.

Tire pressure

Front tires: 14psi

Rear tires: 14psi

Tire size:

Front tires: AT 13/5-6 & AT 14/4.1-6

Rear Tires: AT 13/5-6 & AT 14/5-6

Replacing Tires

Always replace tires with type and size listed in this manual.

Always use the correct tools when replacing tires. The bead and sometimes the rim can be damaged by using the wrong type of tools. It is usually best to have tires replaced by an authorized service center. Service centers have the correct equipment and expertise to change tires without causing damage.

Punctures to tires can usually be repaired by using plug type patches. Plug type patches cannot repair tires that have been cut. If the tire has been cut or has a puncture in a location or size that cannot be repaired, replace the tire.

Be prepared for flat tires, always carry a plug type patch kit and air pump with you.



Minimum tread
4mm (.16 in.)



⚠ WARNING

Operating this Go Kart with worn tires could be hazardous.

Operating this Go Kart with worn tires will reduce traction which could result in an accident.

Never operate this Go Kart with tires that have a tread depth of less than 4mm (0.16 in.).

⚠ WARNING

Operating this Go Kart with improper tire sizes or pressure could be hazardous

Operating this Go Kart with improper tire sizes or pressure could result in loss of control of the Go Kart which could result in an accident.

Never operate this Go Kart with improper tire sizes or pressure.

MAINTENANCE

STORAGE

If the Go-Kart is left unused for an extended period of time proper storage maintenance is required.

1. Wash Go-Kart thoroughly, then wax painted parts with a non abrasive auto wax. Coat vinyl seat and rubber parts with a vinyl/rubber protectant. Note: Keep water away from battery and motor controller while washing to avoid water from entering the engine and/or components.
2. Place the power switch to the off position. Charge the battery once a month at least.
3. Fill tires with correct air pressure.
4. If possible, store Go-Kart in a shed or garage with a cover to protect from dust, dirt and humidity. If the Go-Kart must be stored outdoors, cover completely with a good waterproof cover.

Returning to service

1. Wash Go-Kart thoroughly.

Note: Keep water away from battery and motor controller while washing to avoid water from entering the engine and/or components.

2. Charge the battery.
3. Review this owner's manual and follow the pre-ride inspection procedures.

MAINTENANCE

WASHING THE GO KART

1. Wash mud and dirt off Go Kart with low water pressure from a hose.
2. Wash Go Kart using a mild detergent or car soap using a sponge, soft rag or brush. Do not use any cleaning materials that could scratch the Go Kart.

Note: Be careful not to allow water to enter battery and motor controller, brake cables or switches.

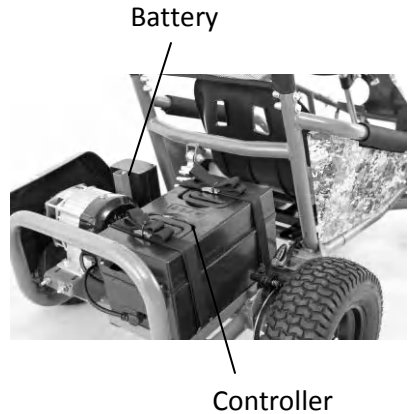

TRANSPORTING

1. Place the power switch to the off position. Take off the power plug from battery case.
3. Transport the Go-Kart in the upright position) tied down securely.

TROUBLESHOOTING

Trouble	Possible cause	Solution
After power on the voltmeter no indication	<ol style="list-style-type: none"> 1, the battery connect cable is bad connect 2, After the short-circuit cable 3, voltmeter plug connection is bad 	<ol style="list-style-type: none"> 1, re-connected securely 2, find the short route 3, re-weld
Has voltage but vehicle does not start	<ol style="list-style-type: none"> 1, battery terminal board contact is not good 2, the battery voltage is too low, the contactor does not pull 3, the motor line off the accelerator pedal 4, the foot brake is not put in the end 	<ol style="list-style-type: none"> 1, re-connected securely 2. Check the battery recharge, or whether failure 3, re-wiring 4, put the foot brake in the end
Brake is unnormal.	<ol style="list-style-type: none"> 1. without resistance 2. brake pad wear 3, uninterruptible power brakes 	<ol style="list-style-type: none"> 1, adjust the brake rod 2, the replacement of brake pads 3, check wiring, replace the brake off switch
The motor does not turn or weakness	<ol style="list-style-type: none"> 1, motor damage 2, the controller bad 3, the controller connection point machine off 	<ol style="list-style-type: none"> 1, the motor maintenance 2, replace the controller 3, re-connected securely
Insufficiently charged	<ol style="list-style-type: none"> 1, the charging socket is damaged 2, damage to the charger 	<ol style="list-style-type: none"> 1, Change socket 2 replacement charger

TORQUE SPECIFICATIONS

FASTNER THREAD SIZE	TORQUE (ft.lbs.) / (in.lbs.)	TORQUE (nm)
5 mm bolts and nuts	39-52 in.lbs.	4.5 - 6 nm
6mm bolts and nuts	69 - 104 in. lbs.	8 - 12 nm
8mm bolts and nuts	13 - 18 ft.lbs.	18 - 25 nm
10 mm bolts and nuts	22 - 29 ft.lbs.	30 - 40 nm
12 mm bolts and nuts	36 - 43 ft.lbs.	50-60 nm
4 mm screws 22-30	22 - 30 in.lbs.	2.5-3.4 nm
5mm screws	30 - 43 in.lbs.	3.5 - 5 nm
6 mm hex bolts	87 - 121 in.lbs.	10 - 14 nm
8 mm hex bolts	17 - 22 ft.lbs.	24 - 30 nm
10 mm hex bolts	25 - 32 ft.lbs.	35 - 45 nm

SPECIFICATIONS

Motor

Type Permanent
Magnet Brush-less
Motor
Voltage 48V
Max Power 1000w
Max Torque 11lb ft (15Nm)
Top Speed 18.7mph (30km/h)

Battery

Battery Type Lead-acid
Capacity 12AH
Charging Time 8H

Charger

Input Voltage AC100-240V
50/60Hz
Max output DC57.6V-2A

Braking

Rear Brake Hydraulic disk

Tires

Front Tire Size AT13/5-6
Rear Tire Size AT13/5-6
Tire pressure 14psi (96.5kpa)

Dimensions and Weights

Length 54.7in. (1390mm)
Height 38.3 in. (975mm)
Width 32 in. (815mm)
Wheelbase 36.2in. (920mm)
Gd. Clearance 2.2in. (55mm)
Vehicle Wt. 198 lbs (90kg)
Weight Cap. 150 lbs. (68kg)

Transmission

Type Planetary
Reducer
Drive System Type Chain
Drive Dual Wheel
Gear Ratio 6:1

Suspension

Front Type Low pressure tires
Rear Type Low pressure tires

VEHICLE IDENTIFICATION NUMBER LOCATION

The Vehicle identification number is needed when calling for parts, service center help or when registering your Go Kart. Locate the number and list the number below for your reference.



The 17 digit Vehicle Identification Number (VIN) is stamped on the left rear bumper support frame on the go-kart.

Vehicle Identification Number:

--	--	--	--	--	--	--	--	--	--	--	--	--	--	--	--	--	--

VIN #

Assembly Instructions



PLEASE NOTE THAT THIS IS NOT THE OWNER'S MANUAL BUT THE ASSEMBLY INSTRUCTIONS ONLY.

BEFORE OPERATING THIS GO-KART, MAKE SURE THE OPERATOR READS AND UNDERSTANDS THE OWNER'S MANUAL, WARNING LABELS AND IS FAMILIAR WITH ALL GO-KART CONTROLS.

PARTS

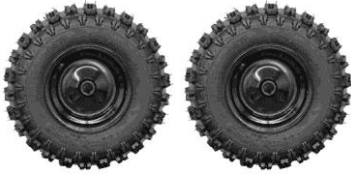

Rear Wheels



Front Wheels



Hardware



Nose Piece



Safety Net



Net Supports



FRONT BUMPER



Tool Kit

FRONT WHEEL ASSEMBLY

Hardware:

M14 Washer 2ea. (A)

M14 Lock Nut 2ea. (B)

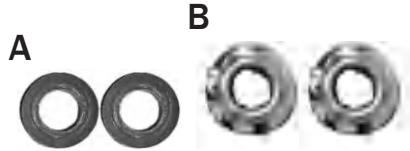

1. Locate front wheels.

Note: Front wheels have bearings on both sides of hubs

2. Install front tires on axles making sure air stem on rim faces out.

3. Attach wheel to axle using hardware in the following order:

Washer (A)

Lock Nut (B)

Tighten lock nut (B) snug. Do not over tighten.

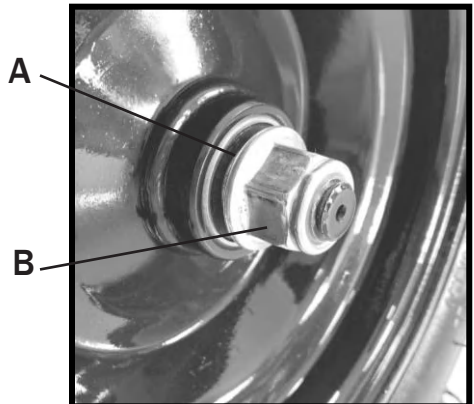
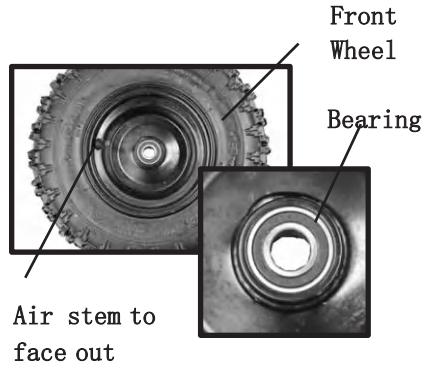

REAR WHEEL ASSEMBLY

Hardware:

- Wheel Spacers 2ea. (A)
- Key 2ea. (B)
- M14 Lock nuts 2ea. (C)

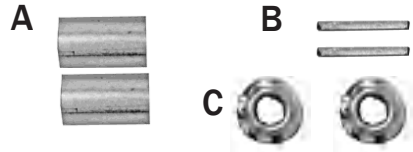

1. Slide wheel spacer (A) over axle
2. Insert Key (B) into Key way groove on axle.
3. Install Tires on rear axle making sure air stem on rim faces out.
4. Attach wheel to axle using the M14 Lock nut (C)
5. Tighten lock nut (C) snug. Do not over tighten.

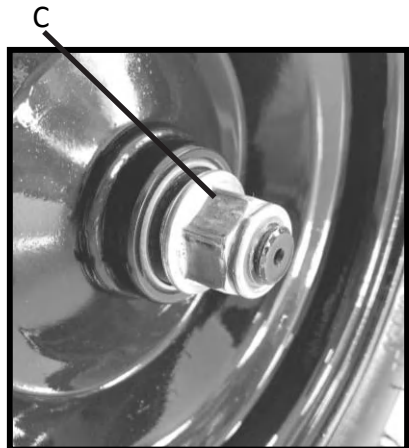
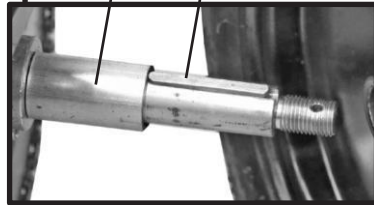
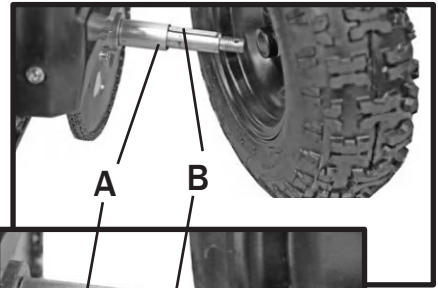
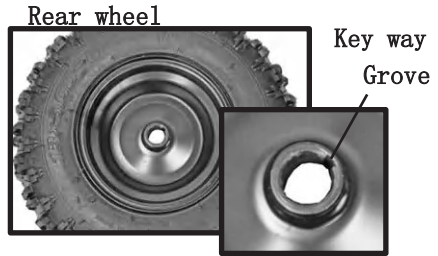

⚠ WARNING

Failing to install cotter pins could be hazardous.
Failing to install cotter pins could cause the wheel to fall off resulting in an accident.
Never operate Go Kart without cotter pins installed

BUMPER ASSEMBLY

Hardware:

M8 x 45 bolts 2ea. (A)

M8 Lock Nuts 2ea. (B)

Bumper 1ea. (C)

1. Install front bumper (C) and attach to Frame using bolts (A) and Lock Nuts (B).

Tighten bolts.



NOSE ASSEMBLY

M6 X 16 Screws 4 ea. (A)
M6 Plastic Flat Washers 4 ea. (B)
Plastic Nose piece 1ea. (C)

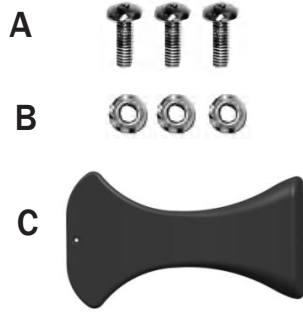

1. Attach front nose piece (C) to frame with Screws (A) and plastic washers (B).

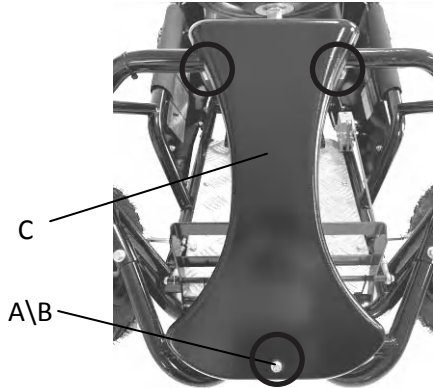

2. Attach wires (D) to ON/OFF switch (E). Note: Colored wires can attach to either terminal.

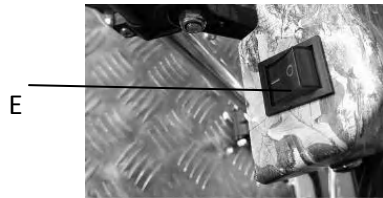

STEERING COLUMN AND SIDE PADS INSTALL

M8 X 35 bolt

1 ea. (A)

M8 Lock Nut

1 ea. (B)

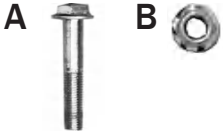

1.Attach steering wheel with Bolt and Nut(C)

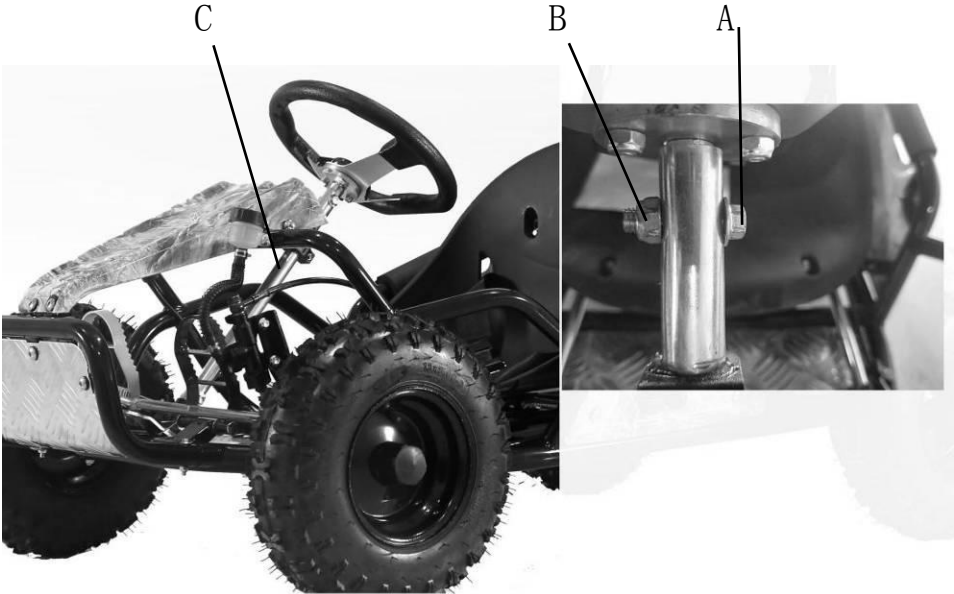

NET SUPPORT ASSEMBLY

M8 X 45 Allen Head bolts 4 ea. (A)

M8 Lock nut 1ea. (B)

Net 1ea (C)

Loop support 1ea. (D)

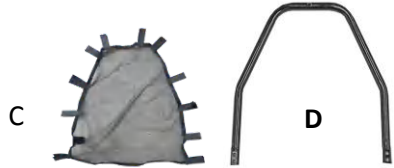

1. Install net to frame using buckles provided .

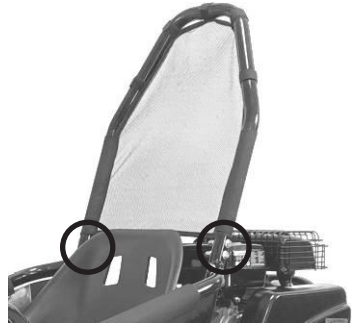

**2. Attach Loop Support(D) to kart frame
With M8*45.**

SHOCKS ASSEMBLY

M8 X 40 bolt
M8 Lock Nut
M8 Washer

3 ea. (A)
3 ea. (B)
2 ea. (C)

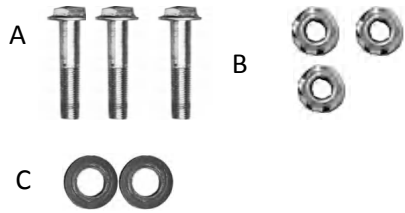

1. Install front shock up side bolt, put the parts like the following order: M8X40 bolt, M8 washer, shock, Frame bracket, M8 lock nut.

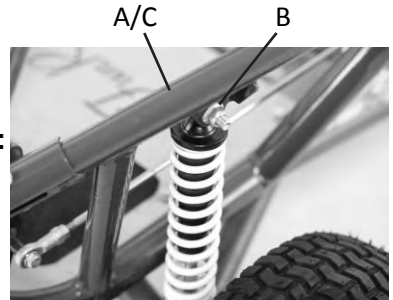

2. Install rear shock up side bolt to kart frame with M8*40bolt and M8 lock nut.

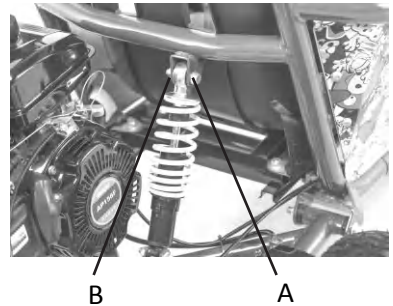

PRE-RIDE INSPECTION

Inspecting and checking the condition of the Go Kart before each ride is important. Following the pre-ride check list will help insure the you do not have mechanical problems which could result in injury or becoming stranded. Make sure the Go Kart is in good operating condition before each ride.

⚠ WARNING

Failing to inspect and maintain your Go Kart could be hazardous.

Not following the pre-ride inspection procedures could result in loosing control of the Go Kart resulting in an accident or damage to the Go Kart

Always perform a Pre-ride inspection before each ride.

⚠ WARNING

Performing maintenance and checks while the engine is running could be hazardous.

You could be severely injured by moving parts or hot surfaces.

Never perform maintenance or check procedures while the engine is running with the exception of checking the ignition switch or throttle.

WHAT TO CHECK	CHECK FOR
Steering	<ul style="list-style-type: none"> • Smoothness • No restriction of movement
Brakes	<ul style="list-style-type: none"> • Stops Kart • Inspect hoses • Correct fluid level • Inspect brake pads for wear.
Tires	<ul style="list-style-type: none"> • Proper tire pressure • Proper tread depth • Rubber has no cracks
Throttle Pedal	<ul style="list-style-type: none"> • Pedal snaps back to idle when released • Operates freely
Motor Ignition switch	<ul style="list-style-type: none"> • Switch shuts off Motor
Safety Net	<ul style="list-style-type: none"> • Securely attached • Good condition
Drive Chain	<ul style="list-style-type: none"> • Proper tension • Lubricated • No excessive wear or damage
General Condition	<ul style="list-style-type: none"> • All nuts and bolts tight • No rattles from engine or frame while running

 WARNING

Never Attempt to start this Go-Kart without reading and understanding the Owner's/Operator's manual. The Owner's/Operator's manual provides information on safety, parts, functions, pre-ride inspection, starting and maintenance.

WARNING

THIS IS SPORTING EQUIPMENT AND NOT A TOY FOR YOUNGER CHILDREN USING THIS PRODUCT MAY BE A DANGEROUS ACTIVITY AND MAY RESULT IN INJURY OR DEATH EVEN WHEN USED WITH PROPER SAFETY PRECAUTIONS. USE AT YOUR OWN RISK.

www.evoltadventure.com

EVOLT



COPYRIGHT © E-VOLT. ALL INFORMATION CONTAINED WITHIN THIS PUBLICATION IS BASED UPON THE LATEST PRODUCT SPECIFICATIONS AND INFORMATION AT THE TIME OF PUBLICATION. BECAUSE OF THE CONSTANT ENHANCEMENT IN THE QUALITY AND DESIGN OF PRODUCTION COMPONENTS, DISCREPANCIES MAY VARY BETWEEN THE ACTUAL VEHICLE AND THE INFORMATION PRESENTED IN THIS PUBLICATION. NO LIABILITY CAN BE ACCEPTED FOR OMISSIONS OR INACCURACIES. ANY REPRINTING OR REPRODUCTION, WHETHER WHOLE OR IN PART OF THIS PUBLICATION IS STRICTLY PROHIBITED.

Version: 10012201